







Fitting for top-running wooden doors up to 60 kg (132 lbs.), with surface mounted running track or running track flush with the ceiling. Sound attenuation. Ceiling mounting. Wall pocket solution.

Product highlights

-  **Comfort** Outstanding living comfort thanks to effective exclusion of sound, drafts, odors and unwanted light incidence
-  **Flexibility** Ceiling-integrated or surface-mounted pocket solutions possible
-  **Productivity** Door can be installed in pocket after construction is complete

Technical specifications

-  **Max.** 60 kg (132 lbs.)
-  **Max.** 2500 mm (8' 2 7/16")
-  750–1250 mm (2' 5 17/32" to 4' 1 7/32")
Inside clearance (LMB)
-  39–45 mm (1 17/32" to 1 25/32")

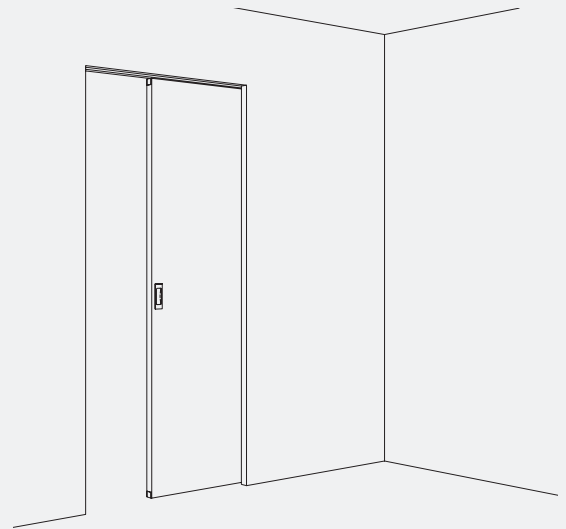



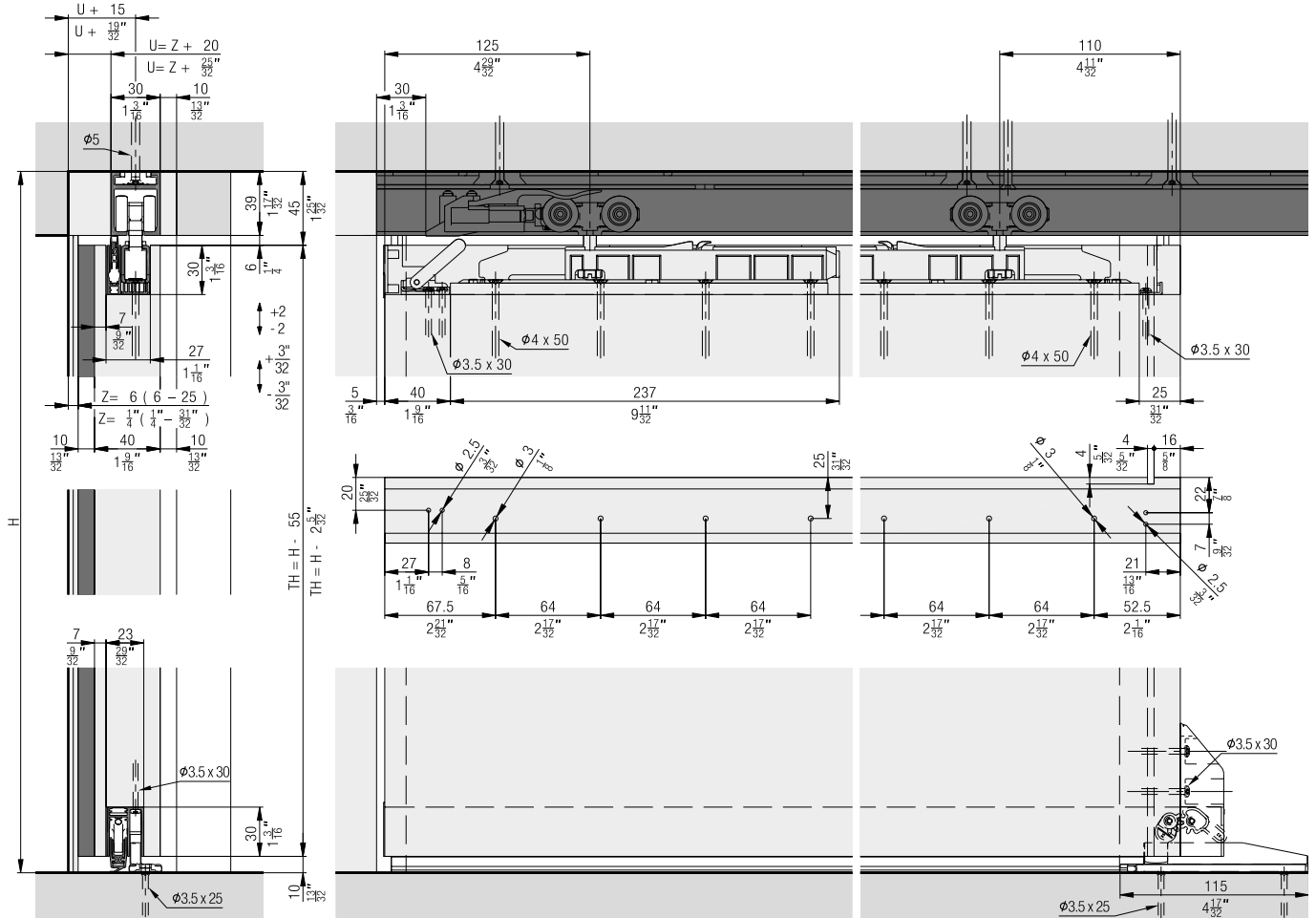









Installation examples



Set for 1 wooden door up to 60 kg (132 lbs.)

	No.
Hawa Porta 60 HMD/HMT Pocket Acoustics, for 1 door	30431



Set consisting of:

	30431	No.
 Running gear, plain bearings, rollers, plastic, blue	2	057.3115.071
 SoftStop Hawa Porta Acoustics, with retention spring, plastic, gray	1	30472
 Stopper, with retention spring, plastic, gray	1	057.3073.072
 Adapter for running gear, for SoftStop, plastic, gray	1	30218
 Pan head screw, M3x8 mm (1/8"x5/16")	1	30359
 Hexagon head screw, M8x36 mm (5/16"x1 13/32"), steel, zinc-plated	1	042.0165.101
 Head cap screw, M8x35 mm (5/16"x1 3/8"), steel, zinc-plated	1	042.0175.001
 Cover cap, plastic, grey	1	600.0000.533
 Running gear holder, plastic, anthracite	2	042.0174.001
 Housing, steel, zinc-plated	2	042.0166.102
 Spacer, housing plastic anthracite	2	30361
 Cover cap set, plastic, anthracite, 4-piece set	1	30484
 Flat countersunk head chipboard screw, 4x50 mm (5/32"x1 31/32"), steel, zinc-plated	8	30463

Accessories for set

	No.
 Spring loaded buffer Hawa Porta 60/100	27760

Running tracks



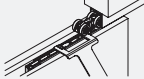

	mm (inch)	No.
	1,700 (5' 6 15/16")	057.3016.170
	2,000 (6' 6 3/4")	057.3016.200
	2,500 (8' 2 7/16")	057.3016.250
	6,000 (19' 8 7/32")	057.3016.600
	cut to size	057.3016.990
	2,000 (6' 6 3/4")	057.3016.201
	2,500 (8' 2 7/16")	057.3016.251
	6,000 (19' 8 7/32")	057.3016.601
	cut to size	057.3016.991
	2,000 (6' 6 3/4")	057.3098.001
	cut to size	057.3098.990

Components for running tracks

	No.
 Track cleaner, plastic, blue	057.3099.071
 Key for dismounting, steel, zinc-plated	042.3119.101

Assembly set

	No.
Assembly set Hawa Porta 60/100, 2000 mm (6' 6 3/4")	057.3179.200
Assembly set Hawa Porta 60/100, 2500 mm (8' 2 7/16")	057.3179.250
Assembly set Hawa Porta 60/100, 3000 mm (9' 10 1/8")	057.3179.300

Set consisting of:		mm (inch)	057.3179.200	057.3179.250	057.3179.300	No.
	Running track, aluminum, anodized, pre-drilled	2,000 (6' 6 3/4 ")	1			057.3174.200
	Assembly pin, plastic, gray		9	11	13	057.0201.001
	Countersunk head screw, 5x40 mm (3/16" x 1 9/16"), steel, zinc-plated		10	12	14	766.3054.140
	Running track, aluminum, anodized, pre-drilled	2,500 (8' 2 7/16 ")		1		057.3174.250
	Running track, aluminum, anodized, pre-drilled	3,000 (9' 10 1/8 ")			1	057.3174.300

**Sets left type
(horizontal seal set)**

		No.
	Seal, Hawa Acoustics XS, left	30437
	Seal, Hawa Acoustics S, left	30439
	Seal, Hawa Acoustics M, left	30441
	Seal, Hawa Acoustics L, left	30443
	Seal, Hawa Acoustics XL, left	30445

**Sets right type
(horizontal seal set)**

		No.
	Seal, Hawa Acoustics XS, right	30436
	Seal, Hawa Acoustics S, right	30438
	Seal, Hawa Acoustics M, right	30440
	Seal, Hawa Acoustics L, right	30442
	Seal, Hawa Acoustics XL, right	30444

Vertical seal for seal set, left, right set type

		No.
	Seal vertical, Hawa Acoustics, 7700 mm (25' 3 5/32"), Silicone, black	30300

**Hawa Acoustics horizontal seal set
consisting of:**

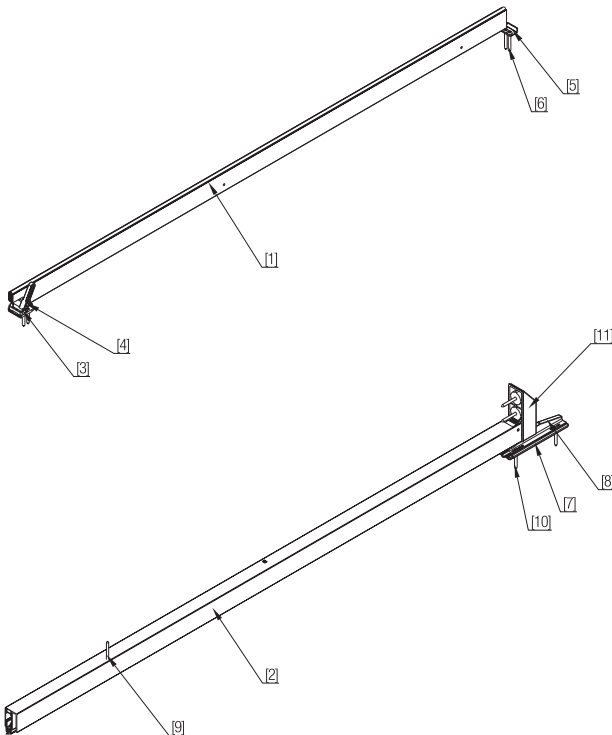

Position Position Position	Bezeichnung Designation Designation	Anzahl Numéro Number	Typ Type Type			
1	Hubdichtung Joint de levage Header seal	1	Links/Rechts Gauche/Droite Left/Right			
			XS	30454		
			S	30385		
			M	30455		
			L	30456		
XL	30457					
2	Senkdichtung Joint d'abaissement Floor seal	1	Links Gauche Left		Rechts Droite Right	
			XS	30446	XS	30447
			S	30387	S	30383
			M	30448	M	30449
			L	30450	L	30451
XL	30452	XL	30453			
3, 4, 5, 6	Kleinteileset oben Kit pour petites pièces, supérieur Small parts set top	1	Links Gauche Left	30390	Rechts Droite Right	30392
7, 8, 9, 10	Kleinteileset unten Kit pour petites pièces, inférieur Small parts set bottom	1	Links Gauche Left	30416	Rechts Droite Right	30417
11	Pocketadapter Adaptateur pour caisson à galandage Pocket adapter	1	Links/Rechts Gauche/Droite Left/Right	30418		

Definition left, right / door width calculation

Left type (left hand lock)

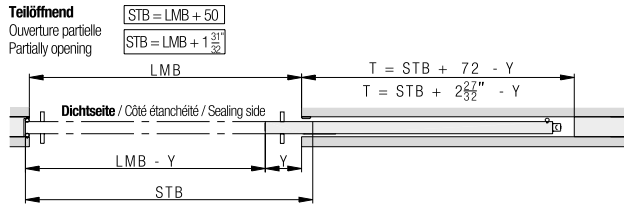
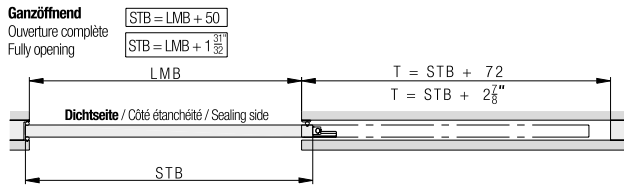

Right type (right hand lock)

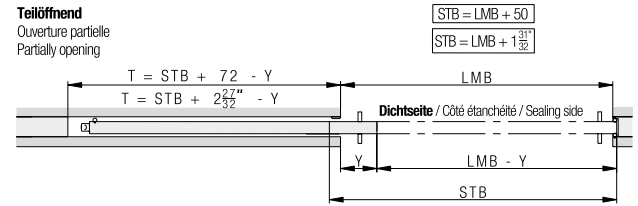
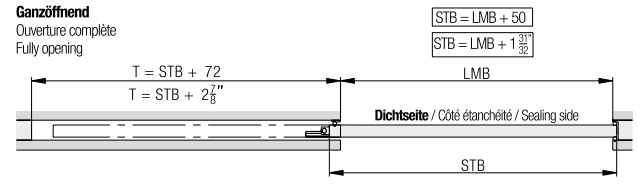

Acoustics set determination

	LMB
Hawa Acoustics XS	750 - 850
Hawa Acoustics S	850 - 970
Hawa Acoustics M	970 - 1100
Hawa Acoustics L	1100 - 1220
Hawa Acoustics XL	1220 - 1250

	LMB
Hawa Acoustics XS	2' 5 $\frac{17}{32}$ " - 2' 9 $\frac{15}{32}$ "
Hawa Acoustics S	2' 9 $\frac{15}{32}$ " - 3' 2 $\frac{13}{32}$ "
Hawa Acoustics M	3' 2 $\frac{13}{32}$ " - 3' 7 $\frac{11}{32}$ "
Hawa Acoustics L	3' 7 $\frac{11}{32}$ " - 4' 1 $\frac{9}{32}$ "
Hawa Acoustics XL	4' 1 $\frac{9}{32}$ " - 4' 1 $\frac{7}{32}$ "

Further installation examples

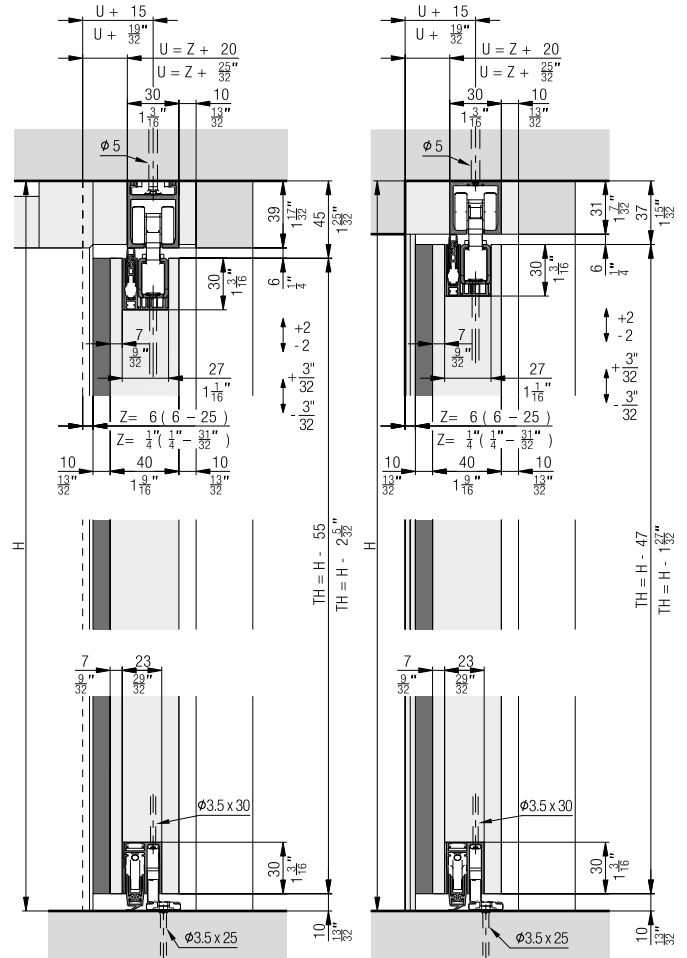

Pocket side view, assembly set

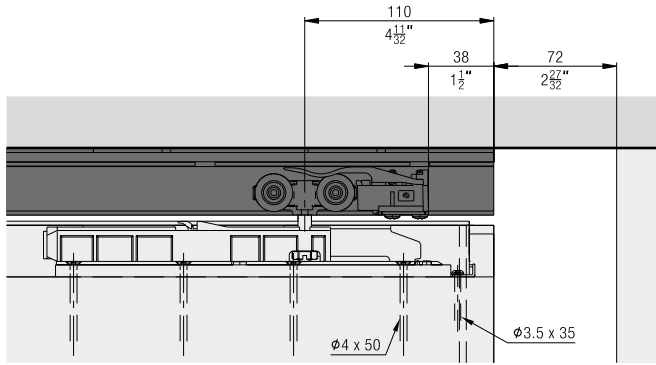

Details of end post at lock side

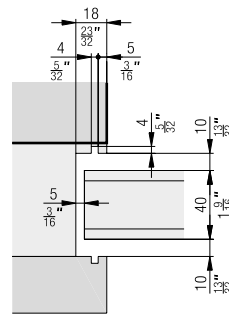

Assembly set/track installation Pocket

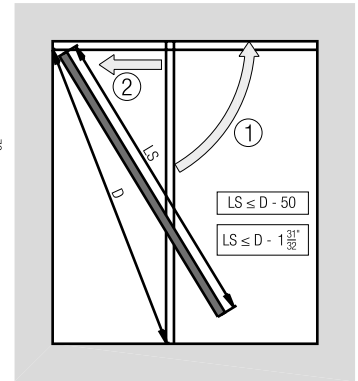
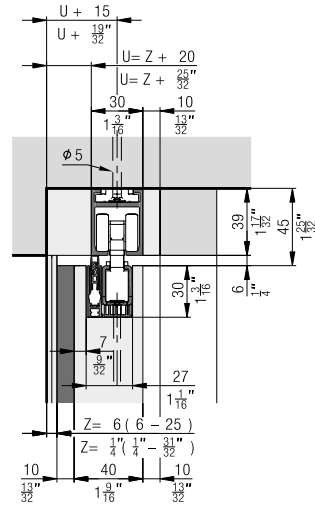
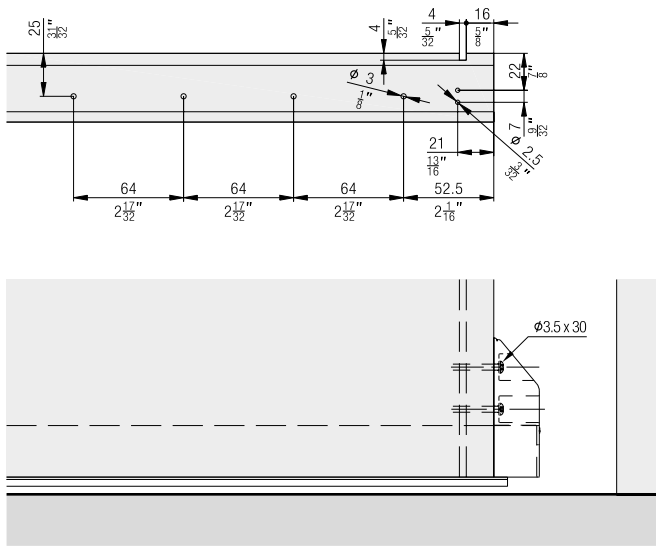

Spring stop

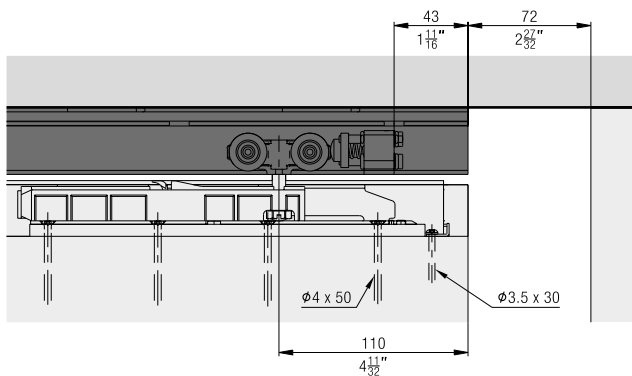

Bottom guide assembly detail

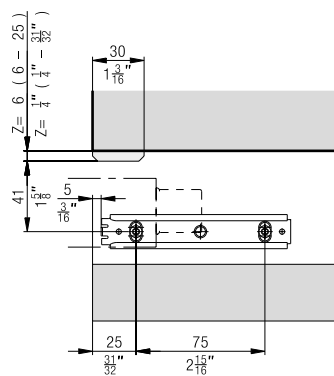

Room-to-room sound attenuation

All reference values have been measured on the basis of a practical design. The R_w sound attenuation values specify the expected sound attenuation between the two rooms which are influenced by the wall, the system and the choice of door leaf.

Reference values tested with a lightweight construction wall in accordance with James Hardy (type 1 H 31 / R_w 52 dB), size 2.5 x 2.45 m in accordance with DIN EN ISO 10140-2. Clearance 2.0 x 1.0 m. The sound attenuation relates to the entire structure and specifies which sound attenuation can be expected between the two rooms.

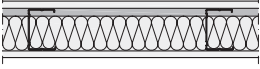
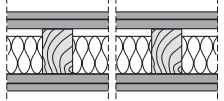
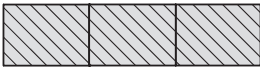
Example walls	System	Thickness of door leaf	Type of door leaf	Estimated sound attenuation effect	
				Room to room R_w	
Wall with minimum acoustic rating of R_w 52 dB	without Hawa Acoustics	39 mm	Single door leaf without sealing system	≈ 18 dB	
Lightweight construction wall with metal stand 	Hawa Porta 60 HMD Acoustics Hawa Porta 100 HMD Acoustics		Single door leaf, approx. 19 kg/m ² acoustic rating of R_w 29 dB	≈ 31 dB	
			Chipboard, approx. 25 kg/m ² No defined acoustic rating	≈ 30 dB	
			Door leaf with medium sound attenuation level approx. 25 kg/m ² , acoustic rating of R_w 39 dB	≈ 34 dB	
		Single door leaf, approx. 20 kg/m ² acoustic rating of R_w 29 dB	≈ 30 dB		
Lightweight construction wall with wooden stand 	Hawa Junior 100 B Acoustics Hawa Porta 60 HMD Acoustics Hawa Porta 100 HMD Acoustics	44 mm	Door leaf with medium sound attenuation level approx. 28 kg/m ² , acoustic rating of R_w 40 dB	≈ 34 dB	
	Hawa Junior 100 B Acoustics	50 mm	Door leaf with high sound attenuation level approx. 33 kg/m ² , acoustic rating of R_w 42 dB	≈ 35 dB	
Solid wall  <p>Acoustic ratings for wall construction according to manufacturer. The acoustic values may vary if installed in different wall types.</p>	without Hawa Acoustics	39 mm	Single door leaf without sealing system	≈ 20 dB	
	Hawa Porta 60 HMT Pocket Acoustics Hawa Porta 100 HMT Pocket Acoustics		Single door leaf, approx. 19 kg/m ² , acoustic rating of R_w 29 dB	≈ 31 dB	
			Door leaf with medium sound attenuation level approx. 25 kg/m ² , acoustic rating of R_w 39 dB	≈ 37 dB	
	Hawa Junior 100 B Pocket Acoustics Hawa Porta 60 HMT Pocket Acoustics Hawa Porta 100 HMT Pocket Acoustics	Hawa Junior 100 B Pocket Acoustics	44 mm	Single door leaf, approx. 20 kg/m ² acoustic rating of R_w 29 dB	≈ 32 dB
			Door leaf with medium sound attenuation level approx. 28 kg/m ² , acoustic rating of R_w 40 dB	≈ 39 dB	
			50 mm	Door leaf with high sound attenuation level approx. 33 kg/m ² , acoustic rating of R_w 42 dB	≈ 41 dB

Planning/execution

Further information about the product can be found on www.hawa.com.